

### Nanopi NEO Headers

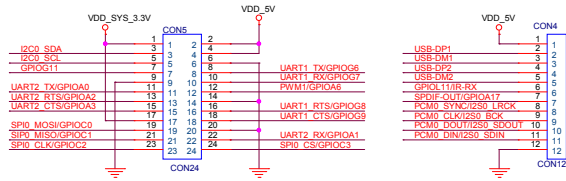

### Arduino Headers

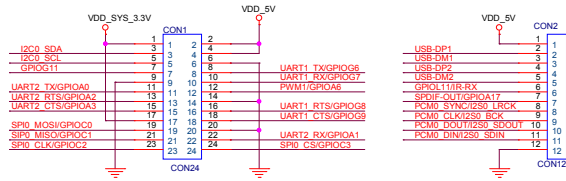
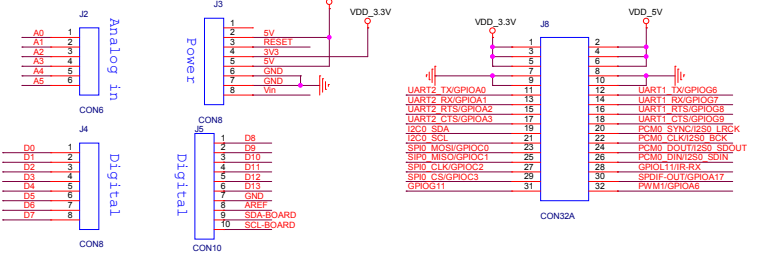

### Debug UART

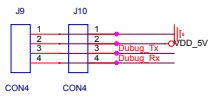

### UART Select

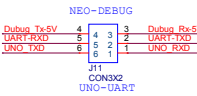

### USB Host X2

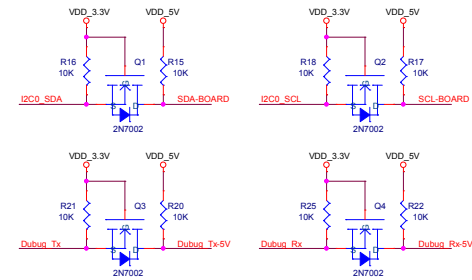
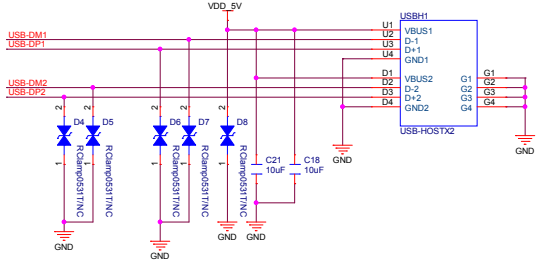

### Power

#### DC 12V

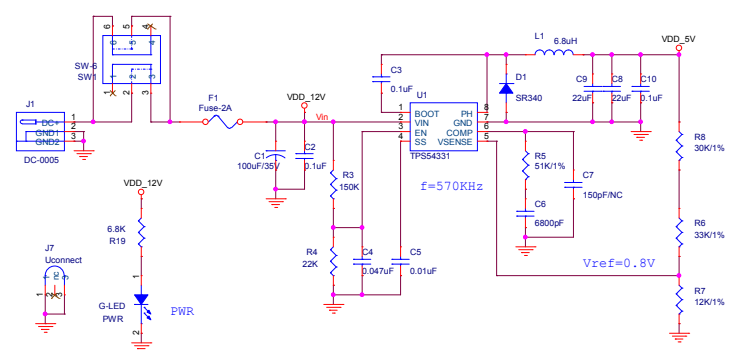

### UNO MCU

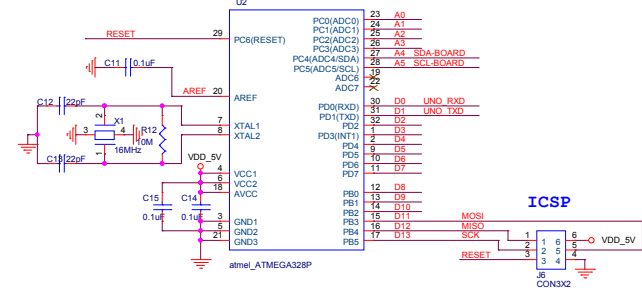

#### MCU Reset

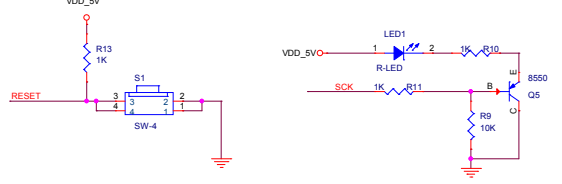

### USB to UART

#### MicroUSB

